



Designation: E 1813 – 96 (Reapproved 2002)

Standard Practice for Measuring and Reporting Probe Tip Shape in Scanning Probe Microscopy¹

This standard is issued under the fixed designation E 1813; the number immediately following the designation indicates the year of original adoption or, in the case of revision, the year of last revision. A number in parentheses indicates the year of last reapproval. A superscript epsilon (ϵ) indicates an editorial change since the last revision or reapproval.

INTRODUCTION

An image produced by a stylus scanning in close proximity to a surface is usually not an exact replica of the surface. The data are subject to a type of distortion called dilation. The amount of dilation depends on the shape and the orientation of the probe as well as the surface topography (1).² Analysis of the scanned probe images thus requires knowledge of the probe shape and orientation.

1. Scope

1.1 This practice covers scanning probe microscopy and describes the parameters needed for probe shape and orientation.

1.2 This practice also describes a method for measuring the shape and size of a probe tip to be used in scanning probe microscopy. The method employs special sample shapes, known as probe characterizers, which can be scanned with a probe microscope to determine the dimensions of the probe. Mathematical techniques to extract the probe shape from the scans of the characterizers have been published (2-5).

1.3 This standard does not purport to address all of the safety concerns, if any, associated with its use. It is the responsibility of the user of this standard to establish appropriate safety and health practices and determine the applicability of regulatory limitations prior to use.

2. Referenced Documents

2.1 ASTM Standards:

F 1438 Test Method for Determination of Surface Roughness by Scanning Tunneling Microscopy for Gas Distribution System Components³

3. Terminology

3.1 Definitions:

3.1.1 *active length*—length of the region of the probe tip that could come into contact with the sample during a scan, and is set by the height of the tallest feature encountered, and it should be less than the probe length (see Fig. 1).

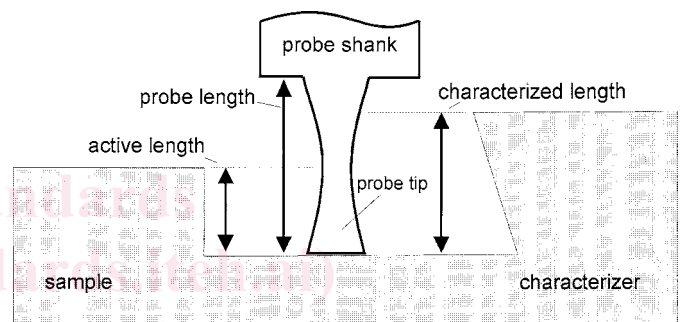

FIG. 1 Probe Tip Characterization

3.1.2 *characterized length*—the region of the probe whose shape has been measured with a probe characterizer (see Fig. 1).

3.1.3 *concave probe*—a probe that is not convex.

3.1.4 *convex probe*—the probe is convex if for any two points in the probe, the straight line between the points lies in the probe.

3.1.4.1 *Discussion*—Conical and cylindrical probes are convex, while flared probes are not. Minor imperfections in the probe, caused for instance by roughness of the probe surface, should not be considered in determining whether a probe is convex.

3.1.5 *dilation*—the dilation of a set A by a set B is defined as follows:

$$A + B = \bigcup_{b \in B} (A + b) \quad (1)$$

The image I produced by a probe tip T scanning a surface S is $I = S + (-T)$ (6). This is the surface obtained if an inverted image of the tip is placed at all points on the surface. The envelope produced by these inverted tip images is the image of the surface (3).

3.1.6 *erosion*—the erosion of a set A by a set B is defined as follows:

¹ This practice is under the jurisdiction of ASTM Committee E42 on Surface Analysis and is the direct responsibility of Subcommittee E42.14 on STM/ATM. Current edition approved June 10, 1996. Published August 1996.

² The boldface numbers in parentheses refer to the list of references at the end of this document.

³ *Annual Book of ASTM Standards*, Vol 10.05.

$$A - B = \bigcap_{b \in B} (A - b). \quad (2)$$

An upper bound for the surface S is $I - (-T)$, where I is the image and $-T$ is an inverted image of the probe tip (5).

3.1.7 *feedback-induced distortion*—distortion of a scan trace arising from the inability of the probe microscope feedback to maintain close proximity between the tip and surface, which can be caused by scanning too quickly and changes with scan speed and scan direction.

3.1.8 *flexing-induced distortion*—distortion of a scan trace arising from flexing of the probe or shank during scanning.

3.1.9 *probe apex*—end of the probe tip, which is farthest from the shank.

3.1.9.1 *Discussion*—For some shapes, the position of the apex is somewhat arbitrary. The apex position coincides with the origin of the coordinate system used to describe the probe.

3.1.10 *probe characterizer*—a structure designed to allow extraction of the probe tip shape from a scan of the characterizer.

3.1.11 *probe flank*—side of the probe in the region between the apex and the shank.

3.1.12 *probe length* L_t —distance between the apex and the shank (see Fig. 1).

3.1.13 *probe shank*—stiff structure supporting the probe tip.

3.1.14 *probe stiffness*—resistance of the probe from flexing caused by lateral forces, expressed as a force constant (N/m) describing the lateral flexing of the probe under an impressed force.

3.1.15 *reconstruction*—an estimate of the surface topography determined by eroding the image with the probe tip shape.

3.1.15.1 *Discussion*—The closeness of the approximation depends on both probe shape and surface topography. Regions in which the estimate is not close are known as unreconstructable regions or dead zones.

4. Coordinate System

4.1 The coordinate system used to describe the probe shape is shown in Fig. 2 and Fig. 3. It is a three-dimensional, right-handed, Cartesian system with mutually orthogonal axes x , y and z . Distance along the axes is measured in nanometers (nm) or micrometres (μm). In many cases, these axes will be parallel to the corresponding axes used for the sample. The z axis is chosen to be parallel to the axis of the probe. If the probe is mounted on a cantilever, the orientation of the x and y axes relative to the cantilever may be relevant because these cantilevers are often tilted.

4.2 If the probe axis is tilted relative to the sample, Eulerian angles should be used to express the orientation of the probe. These angles are shown in Fig. 4. They may be expressed in degrees. The order in which the rotations are applied is important. The first is about the z axis through the angle ϕ . The second is about the x' axis through the angle θ . The final rotation is about the z'' axis through the angle ψ . The positive sense of each rotation is determined by the right-hand screw rule. Example: In a typical scanning force microscope, the cantilever is tilted 10° . If the cantilever is oriented parallel to the y axis before being tilted, then the orientation would be $\theta = -10^\circ$, $\phi = 0^\circ$ and $\psi = 0^\circ$.

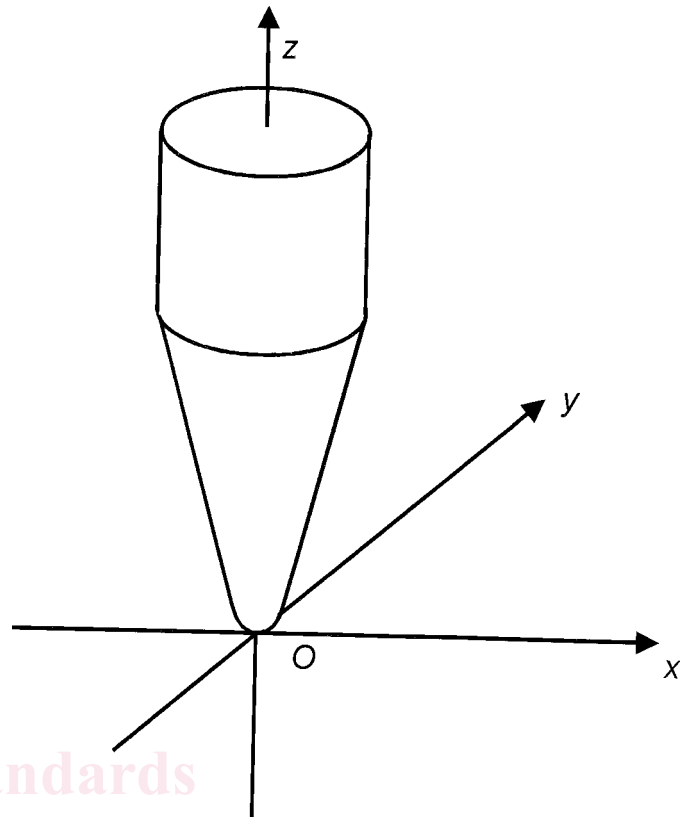

FIG. 2 Probe Tip Coordinates

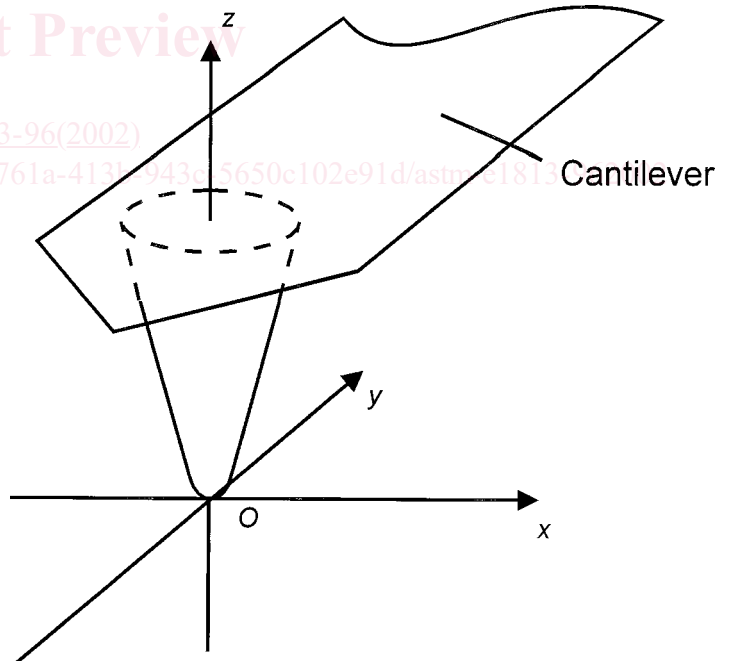

FIG. 3 Coordinates Relative to Cantilever Orientation

5. Description of Probe Shapes

5.1 Probe tips usually have shapes that approximate regular geometrical solids, such as cones or cylinders. Because of imperfections in manufacture or erosion during use, however, data are often collected with probes that are somewhat irregular. The most precise way to describe a probe is the method

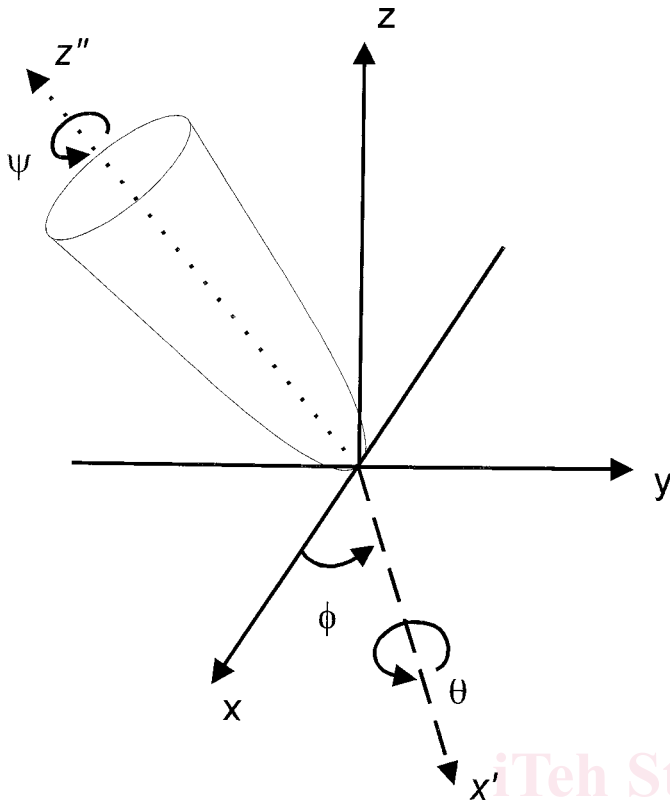

FIG. 4 Tip Rotations

described in 5.2. In many cases, such a thorough description is not needed or is not practical. Consequently, a more economical method for describing good-quality probes that closely conform to a regular geometrical shape is presented in 5.3 and in Appendix X1.

5.2 *General Shapes*—The surface of a probe tip can be presented in precisely the same ways that a sample surface can. An example of such a presentation is shown in Fig. 5, an image of a probe tip generated with software designed to interpret scans from a probe tip characterizer (4). In such a presentation, the axis of the probe is defined to be parallel with the z axis. Eulerian angles are not required to express the orientation of

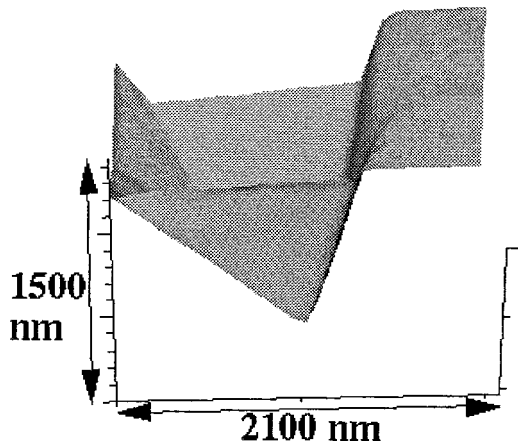

FIG. 5 Probe Tip Shape Reconstructed from a Scan of a Probe Characterizer (Reprinted with permission: G.S. Pingali and the Regents of the University of Michigan, Ref (4))

the probe. The surface is defined by an array of data points on a rectangular grid lying in the x - y plane. Alternatively a pair of line cuts through the probe surface can be used to represent the probe shape along orthogonal directions. The appropriate orientation of the line cuts will depend on the probe shape and the sample scanned. The probe surface extracted from a scan of a characterizer automatically determines the characterized length. If the probe is slender, the total length should also be given.

5.3 *Analytical Shapes*—If the probe is sufficiently regular, the shape can be expressed with a few parameters corresponding to a given geometrical shape. Though this mode of description is not as complete as that of the previous section, it may be preferred for several reasons. First, the complete, general shape may not be available. Second, the measurement performed with the tip may not demand the general description. Finally, a few analytical parameters are a much more economical way to express one or more figures of merit for the probe. The most commonly encountered shapes are listed in Appendix X1. The relevant analytical parameters appear in parentheses at the beginning of each description. Through the shape name and the analytical parameters, anyone analyzing the data presentation will be able to determine the effect of the probe on the data.

6. Description of Probe Characterizer Shapes

6.1 *Probe Characterizer Types*—Just as there is no probe tip appropriate for all surfaces, there exists no probe tip characterizer suitable for all probes. These characterizers generally fall into two classes, those for measuring probe apex radius and those for measuring the shape of the probe flanks. Most available characterizers fall into the first class.

6.2 *Apex Radius Measurement*—In instances, such as surface roughness measurement of smooth surfaces, where only the radii of curvature of the probe apex is needed, a small object with known radius of curvature may be used as a probe characterizer. Possible shapes are shown in Fig. 6. The left-hand shape is simply a small sphere of known radius. The right-hand shape may be either a feature with a sharp tip or it may be a linear feature with a sharp edge. Spheres such as colloidal metal particles or latex are described below. Sharp points may be provided by surfaces that produce sharp protrusions, such as specially prepared Niobium (Nb) films. Sharp linear features may be produced from crystalline surfaces through special etching procedures.

6.3 *Probe Flank Measurement*—If the characterized length must be more than a few nanometres, then a flared characterizer, shown in Fig. 7, should be used. Its height, H_c , should be

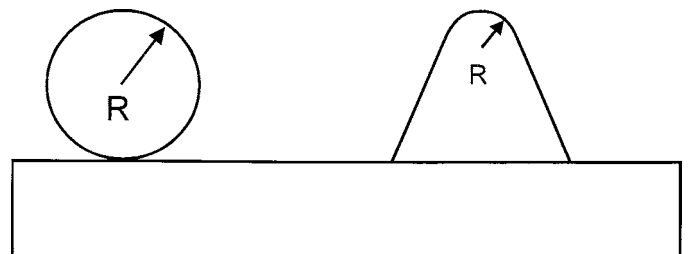

FIG. 6 Point and Edge Characterizers

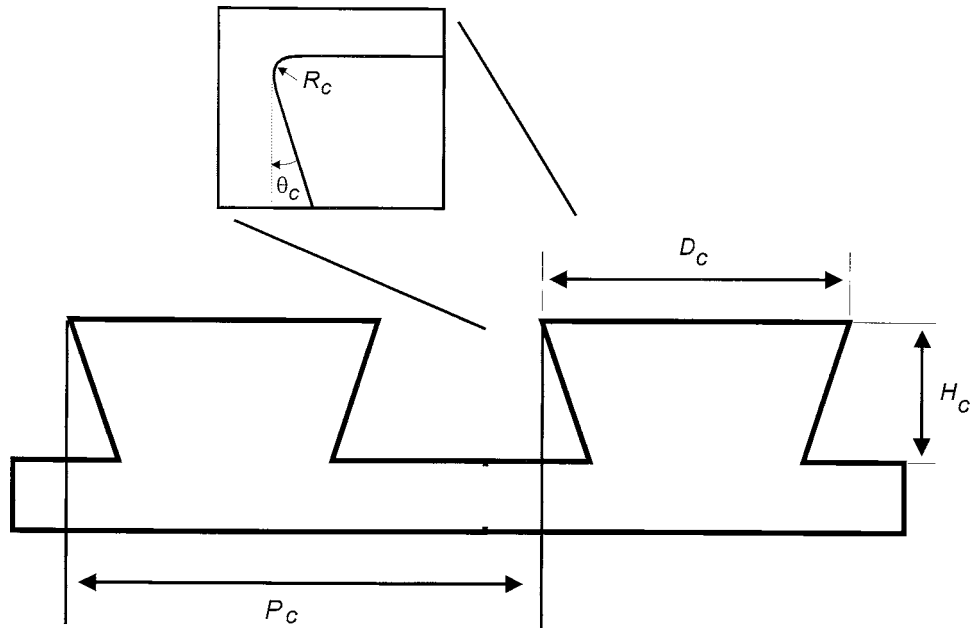

FIG. 7 Flared Probe Tip Characterizer

greater than the height of the tallest object to be scanned. When the characterizer is scanned with the probe, the image will contain probe tip images, which can be extracted with suitable software. These flared features may be either one-dimensional linear structures or two-dimensional plateaus.

6.4 Embodiments of Probe Characterizers:

6.4.1 *Gold Colloid*—Colloidal gold particles have multiple uses as SPM imaging standard because they are incompressible, stable monodisperse, and spherical. The particles are available with three different diameters: 5.72 nm, 14.33 nm, and 27.96 nm. Users can choose different sizes depending on their applications. The particles can be absorbed on a substrate (such as mica) along with biomolecules. The uniform spherical shape of gold particles will give useful information about the nano-geometry of the probe tip (6). Fig. 8 shows an AFM image of gold colloids in distilled/deionized water and adsorbed on to treated mica surface. All three sized particles are present in the 1 by 1- μm scanned area. Image distortion due to tip artifacts are present as well.

6.4.2 *Strontium Titanate Crystal (SrTiO₃)*—A high-temperature-treated (305) surface of SrTiO₃ results in a surface with alternating (101) and (103) crystal planes and thus form large terraces. As shown in Fig. 9, the surface was characterized by transmission electron microscopy (TEM) and revealed the terraces with defined inclinations with respect to the surface plan (305) of +14° and -11.6°, respectively. Reference (7) can be used to characterize the radius of a probe apex. Fig. 10 shows a series of profiles recorded with different commercial probes. The topmost profile demonstrates a Si₃N₄ probe that has a sharp probe apex, while Profile 2 and 3 reveal a truncated probe apex of other Si₃N₄ tips. Both an Si tip and e-beam-deposited tip have a rounded probe apex as shown in the rest of the profiles.

6.4.3 *Polycrystalline Nb Film*—An Nb thin film (8,9) deposited on a silicon wafer by an electron-beam evaporation

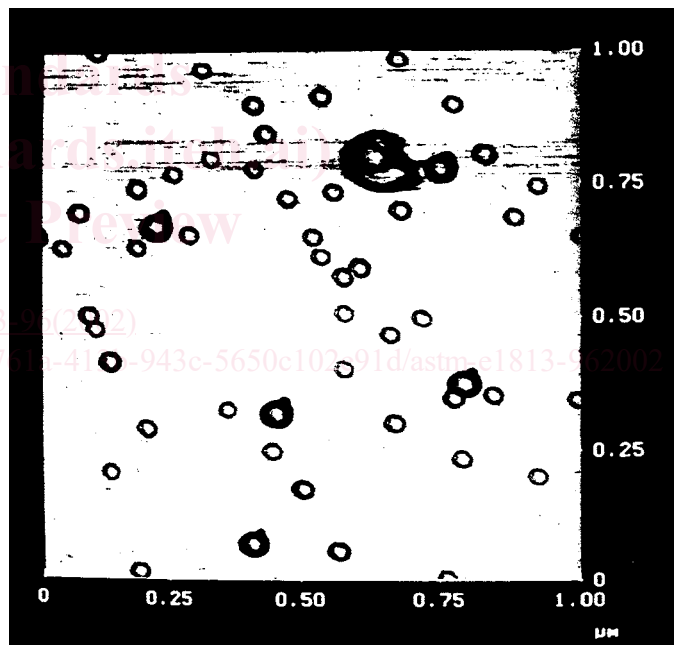

FIG. 8 Colloidal Gold Probe Characterizer (Reprinted with permission: A.T. Giberson, Ref (6))

method has a dense columnar microstructure. The surface was characterized using a field-emission SEM (FESEM) and found to be composed of very sharp pyramidal features. These features are sharp enough that AFM images of this surface correspond to images of tip, instead of the thin film surface. Fig. 11 shows an AFM image of the Nb thin film. If the probe apex of the AFM tip is assumed to be spherical, it is possible to determine the radius of the probe apex from a cross section of the AFM image. The radius of the probe apex can be calculated to be as follows:

$$R = (h^2 + (w/2)^2)/2h \quad (3)$$

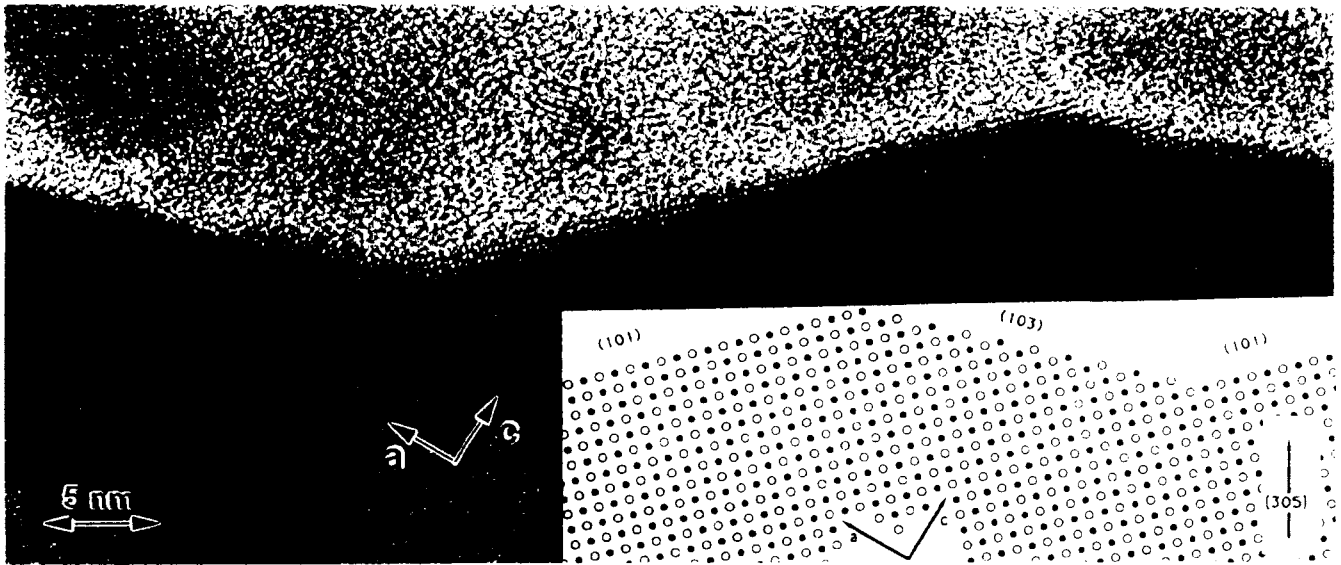

FIG. 9 Transmission Electron Microscopy (TEM) Image of a (010) Cross Section Through a SrTiO₃ Crystal (Reprinted with permission: M. Moller, Ref (7))

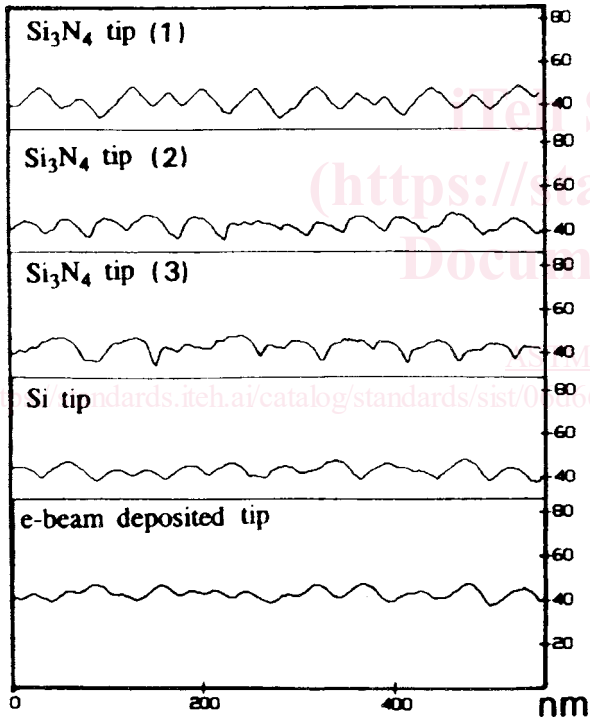

FIG. 10 Two-dimensional Profiles Obtained with a Variety of Probe Tips (Reprinted with permission: M. Moller, Ref (7))

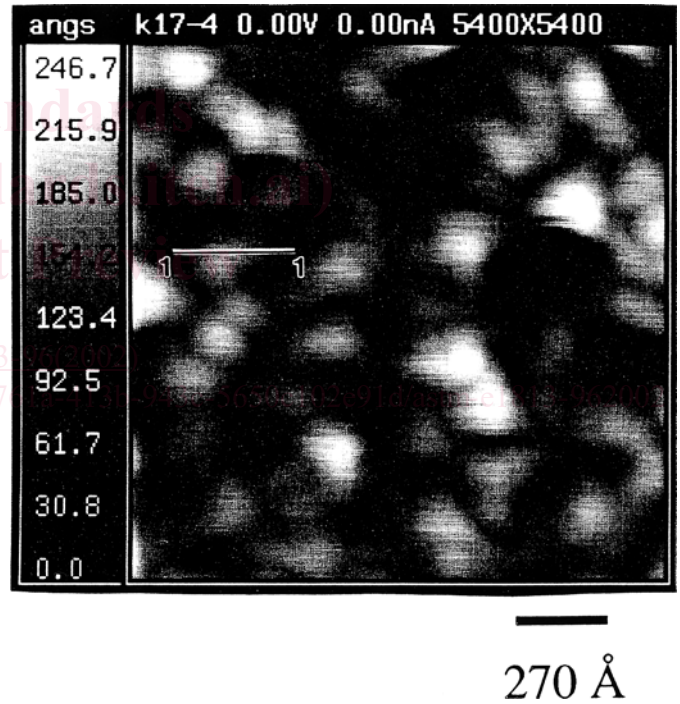

FIG. 11 AFM Image of an e-beam-Evaporated Nb Thin Film (Reprinted with permission: K.L. Westra, Ref (8))

where

w = width of the feature, and

h = height (see Fig. 12).

6.4.4 Polystyrene Latex Particles—The polystyrene latex particles (10) have uniform spherical shape with size distributions ranging from 60 to 500 nm. Using appropriate tip shape extraction software, the geometry of the probe shape can be extracted as with the colloidal gold. The latex particles must adhere stably to the substrate to allow reproducible scanning.

6.4.5 Etched Silicon Ridges and Edges—Etched silicon surfaces can produce sharp edges. Two shapes are available.

They are shown in Figs. 13 and 14. Fig. 13 is a linear sawtooth structure with edge radii of approximately 5 nm. Fig. 14 is a flared structure with edge radii less than 10 nm and a height of 3 to 4 μm .

7. Significance and Use

7.1 The shape and orientation of the probe tip determines which information can be reliably extracted from a scan. This applies to all types of scans. For instance, in surface roughness measurement, the probe tip radius has a profound effect on the

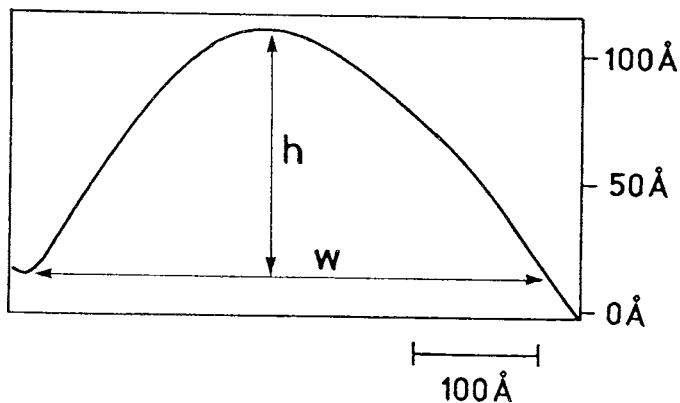

FIG. 12 A Cross Section Through the Line 1-1 in Fig. 11
(Reprinted with permission: K.L. Westra, Ref (8))

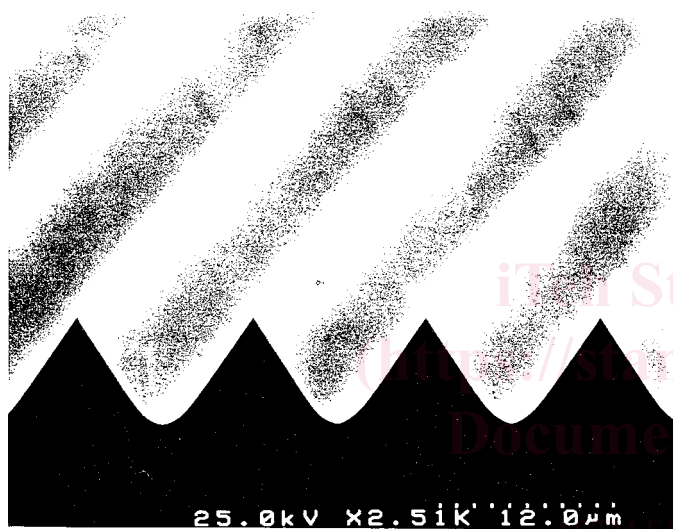

FIG. 13 Etched Silicon Edges (Reprinted with permission: J. Greschner, Ref (11))

spatial frequencies that the probe can reliably measure. Consequently, in reporting data from a probe microscope, it is important to obtain and include in the report information about the shape of the probe tip.

8. Procedure

8.1 Determine the probe orientation, which should be specified by the manufacturer.

8.2 Choose a probe characterizer that can reveal the required probe parameters. For instance, if holes 1 μm deep are to be scanned, then a characterizer at least 1 μm tall must be used. If a tip radius of a given size is needed then the characterizer should have features with a high enough curvature to allow the radius to be revealed. A table matching tip shapes with characterizer shapes may be suitable. Align the probe characterizer so that the probe is perpendicular to it.

8.3 Scan the characterizer with the probe microscope. To verify that the feedback loop is faithfully following the surface,

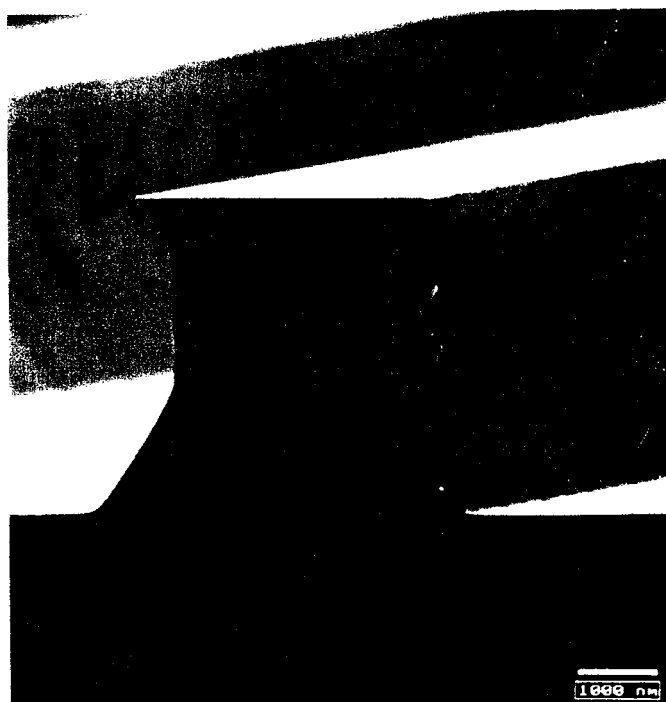

FIG. 14 Flared Silicon Ridges (Reprinted with permission: J. Greschner, Ref (11))

the image obtained from the characterizer must not change if scan speed or scan direction are varied. The scan mesh should be fine enough to reveal the relevant features on the probe. If, for instance, the probe radius is 10 nm, then the mesh should be less than 10 nm. Verify that the data are reproducible at the level required to reveal the probe shape.

8.4 Apply the analysis techniques of References (2-5) to determine the probe shape. A complicated shape may require appropriate software. The analysis may, on the other hand, be straightforward. If, for instance, the width of a cylindrical probe tip is being measured, then the width of the probe is simply the width of the characterizer subtracted from the apparent characterizer width in the image.

8.5 Choose the data presentation format. If the probe shape has a simple geometry, then the parameters listed in Appendix X1 may suffice. More complicated shapes may require a presentation similar to that of Fig. 5. A plot of a line cut through the probe tip may also be appropriate.

9. Precision and Bias

9.1 The precision of the measurement is affected by roughness of the characterizer, data point spacing, stability of the probe, noise in the force sensor, and hysteresis in the scan head. Bias can arise from a character with width that is incorrect. It can also arise from an erroneous pitch calibration of the scan head.

10. Keywords

10.1 microscopy; probe; scanning