



Designation: E2619/E2619M – 17

# Standard Practice for Measuring and Calculating Building Loss Features That Take Up Floor Area in Buildings<sup>1</sup>

This standard is issued under the fixed designation E2619/E2619M; the number immediately following the designation indicates the year of original adoption or, in the case of revision, the year of last revision. A number in parentheses indicates the year of last reapproval. A superscript epsilon ( $\epsilon$ ) indicates an editorial change since the last revision or reapproval.

## 1. Scope

1.1 This practice specifies how to measure certain characteristics of a building, known as building loss features, inside the exterior gross area of a floor and how to calculate the amount of *actual* and *effective* floor area that will be not be available for the placement of people's workplaces, furniture, equipment, or for circulation, if using standard furnishings and orthogonal furniture systems.

1.2 This practice can be used to specify a performance requirement to limit the amount of floor area that may be taken up by building loss features.

1.3 This practice can be used to assess how well a design(s) for an office facility meets a performance requirement regarding floor area.

1.4 This practice can be used to assess how well a constructed office building has met a performance requirement regarding floor area.

1.5 This practice is not intended for and not suitable for use for regulatory purposes, fire hazard assessment, and fire risk assessment.

1.6 Users of this practice should recognize that, in some situations, the amount of certain *actual* and *effective* floor area losses may be mitigated to some degree at some cost by custom-tailoring spaces and creating specially fitted furnishings and carpentry to get some value from space which would not otherwise be usable.

1.7 The values stated in either SI units or inch-pound units are to be regarded separately as standard. The values stated in each system may not be exact equivalents; therefore, each system shall be used independently of the other. Combining values from the two systems may result in non-conformance with the standard.

1.8 *This standard does not purport to address all of the safety concerns, if any, associated with its use. It is the*

<sup>1</sup> This practice is under the jurisdiction of ASTM Committee E06 on Performance of Buildings and is the direct responsibility of Subcommittee E06.25 on Whole Buildings and Facilities.

Current edition approved Oct. 1, 2017. Published November 2017. Originally approved in 2008. Last previous edition approved in 2009 as E2619/E2619M – 09<sup>ε1</sup>. DOI: 10.1520/E2619\_E2619M-17.

*responsibility of the user of this standard to establish appropriate safety, health, and environmental practices and determine the applicability of regulatory limitations prior to use.*

1.9 *This international standard was developed in accordance with internationally recognized principles on standardization established in the Decision on Principles for the Development of International Standards, Guides and Recommendations issued by the World Trade Organization Technical Barriers to Trade (TBT) Committee.*

## 2. Referenced Documents

2.1 *ASTM Standards:*<sup>2</sup>

E631 [Terminology of Building Constructions](#)  
E1836/E1836M [Practice for Building Floor Area Measurements for Facility Management](#)

2.2 *ANSI Standard:*<sup>3</sup>

ANSI/BOMA Z65.1–1996 [Standard Method for Measuring Floor Area in Office Buildings](#)

2.3 *Other Standards:*<sup>4</sup>

ASHRAE 62.1–2007 [Ventilation for Acceptable Indoor Air Quality](#)

## 3. Terminology<sup>5</sup>

3.1 *Definitions:*

3.1.1 *facility, n*—a physical setting used to serve a specific purpose.

<sup>2</sup> For referenced ASTM standards, visit the ASTM website, [www.astm.org](http://www.astm.org), or contact ASTM Customer Service at [service@astm.org](mailto:service@astm.org). For *Annual Book of ASTM Standards* volume information, refer to the standard's Document Summary page on the ASTM website.

<sup>3</sup> Available from American National Standards Institute (ANSI), 25 W. 43rd St., 4th Floor, New York, NY 10036, <http://www.ansi.org>.

<sup>4</sup> Available from American Society of Heating, Refrigerating, and Air-Conditioning Engineers, Inc. (ASHRAE), 1791 Tullie Circle, NE, Atlanta, GA 30329, <http://www.ashrae.org>.

<sup>5</sup> Certain definitions of terms in this practice were agreed in 2007 by a Working Group established jointly by the Building Owners and Managers Association (BOMA) International and the International Facility Management Association (IFMA). Certain terms were derived from referenced ASTM standards or from referenced ANSI standard, or from published IFMA documents. Ownership of copyright to specific terms is indicated by footnotes. Certain terms are quoted from other ASTM standards, in which case the ASTM source is identified at the end of the definition.

3.1.1.1 *Discussion*—A facility may be within a building, a whole building, or a building with its site and surrounding environment; or it may be a construction that is not a building. The term encompasses both the physical object and its use.

**E631**

3.1.2 For standard definitions of additional terms applicable to this practice, see Terminology **E631**.

### 3.2 Definitions of Terms Specific to This Standard:

3.2.1 *actual loss, n—of floor area*, floor area not available for the placement of people’s workplaces, furniture, or equipment or for circulation because occupied by a physical building feature or required by law or regulation.

3.2.2 *building loss factor, n—in a facility*, expressed as a percentage of a facility’s *exterior gross area*, the space not actually or effectively available for planning because of building configuration.

3.2.2.1 *Discussion*—It is the floor area percentage that must be used for excess circulation, oversize footprints, “dead space,” or encroachments because of floorplate configuration.

3.2.3 *building loss feature, n—element of a building*, or aspect of its design, inside the exterior gross area, that cost floor area which could otherwise be used for the placement of people’s workplaces, furniture, or equipment or for circulation.

3.2.4 *dominant portion, n—the inside surface of the outside wall*. **ANSI/BOMA Z65.1–1996<sup>6</sup>**

3.2.5 *effective loss, of floor area, n—floor area not available for the placement of people’s workplaces, furniture, or equipment or for circulation because of configuration of building elements or legally binding document*.

3.2.5.1 *Discussion*—Occurs typically if using standard or manufactured furnishings or orthogonal furniture system(s) in a floorplate with a non-orthogonal configuration, but this sometimes may be partially mitigated by using specially-built or built-in furnishings. An example of a legally binding document is a requirement in a lease.

3.2.6 *exterior gross area, n—the area of the floor measured to the outside face of the walls that enclose the floor(s) of the building*.

3.2.6.1 *Discussion*—Areas which are not enclosed, such as patios and balconies, are not part of exterior gross area. Cornices, pilasters, buttresses, and so forth that extend beyond the wall face are disregarded. The exterior gross area of a basement space includes the area measured to the outside face of basement or foundation walls. A balcony that is *not fully enclosed*, whether or not it extends beyond the line of the outside wall face, is not included in the exterior gross area.

3.2.7 *floor area, n—area in the horizontal plane of the bottom level of a story or stories in a building*.

3.2.8 *floorplate, n—entire floor of a building*, thought of as a solid plane with specific shape and dimensions.

3.2.9 *interior encroachment, n—base building element that is located inside a building*, not on an outer wall, and prevents the use of the floor area for furniture, equipment, circulation, or other occupant function.<sup>7</sup>

3.2.9.1 *Discussion*—Examples include but are not limited to: pilaster, convector, baseboard heating unit, radiator.

3.2.10 *interior gross area, n—portion of the floor(s) that is totally enclosed within the dominant portion*.<sup>7</sup>

3.2.11 *occupied zone, n—region within an occupied space between planes 75 and 1800 mm [3 and 72 in.] above the floor and more than 600 mm [2 ft] from the walls or fixed air-conditioning equipment (see ASHRAE 62.1–2007)*.

3.2.12 *orthogonal, n—relating to or composed of right angles*.

3.2.13 *perimeter encroachment, n—base building element or restricted area that is located inside the dominant portion of a building on the outer wall and that prevents the use of the floor area for furniture, equipment, circulation, or other occupant function*.<sup>7</sup>

3.2.13.1 *Discussion*—Examples are windowsills inside the dominant portion, pilasters, and columns attached to the outside walls and convectors.

3.2.14 *plannable area, n—plannable gross area less the area taken up by major vertical penetrations, void areas, service areas, and either primary circulation on an occupied or planned floor or base building circulation on an empty floor*.

3.2.15 *plannable gross area, n—portion of a floor that is totally enclosed within the interior face of perimeter encroachments at the floor plane and where there are no perimeter encroachments enclosed at the inside finished surface of the exterior walls*.<sup>8</sup>

3.2.15.1 *Discussion*—Plannable gross area typically excludes perimeter encroachments that prevent the placement of the occupant’s furniture and equipment.

3.2.16 *planning grid, n—grid to which building elements such as the ceiling, the partitions, and the columns are aligned*.

3.2.17 *primary circulation, n—minimum path on a floor for access to egress stairs, elevator lobbies, toilet rooms, refuge areas, building lobbies, and entrances*.<sup>7</sup>

3.2.18 *standard space module, n—unit of floor area with dimensions set as standard for a category of offices or workstations*.

## 4. Significance and Use

4.1 Use this practice to identify and measure the amount of *actual* and *effective* floor area that will be unavailable to occupants for the placement of people’s workplaces, furniture, and equipment or for circulation.

4.2 Findings from use of this practice are intended for optional inclusion with reports of floor area measured in

<sup>6</sup> In the 1996 edition, which is copyright by BOMA, the dominant portion is defined as the inside face of the portion of the wall which is window glass where it is more than 50 % of the vertical distance from finished floor to finished ceiling, and elsewhere is the inside face of the outside wall, or of a pilaster or column attached to the outside wall where they occur. Note that the reader is cautioned that ANSI/BOMA Z65.1–1996 is developed by and subject to the authority of BOMA International, which may change it from time to time at its sole option. It is not defined as a part of this ASTM standard.

<sup>7</sup> ASTM International copyright is shared with BOMA International.

<sup>8</sup> New term for which copyright is shared by ASTM International and BOMA International.

accordance with Practice E1836/E1836M or in accordance with ANSI/BOMA Z65.1-1996.

NOTE 1—The choice between using Practice E1836/E1836M or ANSI/BOMA Z65.1-1996 as the basis for measurement depends on the objectives of the analysis. Practice E1836/E1836M is oriented to the traditional interests of design professionals and would be particularly suitable for single-tenant buildings whereas some categories of space measured by ANSI/BOMA Z65.1-1996 are oriented to the leasing of multi-tenant buildings by real estate professionals.

4.3 this practice is not intended for use for regulatory purposes, nor for fire hazard assessment, nor for fire risk assessment.

5. Basis of Practice

5.1 Use this practice to specify a performance requirement to limit the amount of floor area that is permitted to be taken up, or is actually taken up by, building features inside the exterior gross area, as measured in accordance with Practice E1836/E1836M.

5.2 Use this practice to assess how well a design(s) for an office facility meets such a performance requirement.

5.3 Use this practice to assess how well an existing office facility has met a performance requirement.

5.4 Use this practice to compare how well different buildings or facilities meet a performance requirement. This practice is applicable despite differences such as location, structure, mechanical systems, age, and building shape.

5.5 Use this practice to calculate the amount of variance from a performance target about floor area during design and construction phases.

6. Procedure for Measurement and Calculation

6.1 This practice practice uses imperial units to measure floor area. Other measurement units can be used to measure floor area.

6.2 For each building element or aspect of design, measure the actual loss of floor area and the effective loss using the method and measurement sequence in this practice.

6.3 Location of the Dominant Portion:

6.3.1 Determine the location(s) of the Dominant Portion of the inside face of the exterior walls, as defined in ANSI/BOMA Z65.1-1996.

6.4 Exterior Walls—Size, Shape, and Dimensions:

6.4.1 Buildings vary in their capacity to accommodate different sizes and categories of occupants without excessive waste of floor area, while maintaining other levels of service.

6.4.2 The geometry of a building’s typical floors (for example, shape and dimensions formed by the exterior building walls and dimensions of its grid) will affect how much space will be lost because it cannot be subdivided into rooms or workstations.

6.4.3 If designs for the geometry and building grid dimensions do not take this into account, then the amount of floor area available for planning and fitup may be substantially reduced.

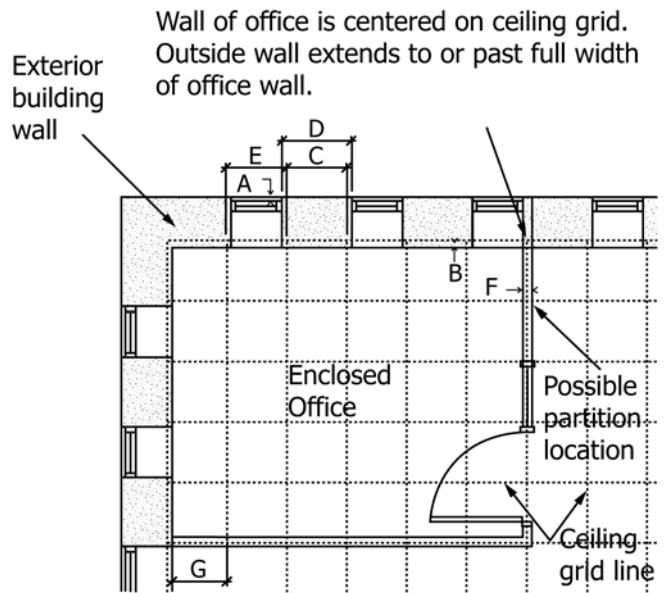

NOTE 1—A = 50 mm [2 in.]  
 B = 100 mm [4 in.]  
 C = 600 mm [24 in.]  
 D = 700 mm [28 in.]

FIG. 1 No Actual or Effective Loss Due to Exterior Wall and Its Relation to Ceiling Grid

6.4.4 Irregular exterior walls, non-orthogonal exterior walls, and the dimensions of the space can severely limit and even dictate the nature of the fitup on a floor.

6.5 Exterior Wall and Its Relation to the Ceiling Grid:

6.5.1 The example shown in shows a condition in which there is no effective loss due to either the design of the floorplate, the resulting dimensions formed by the building’s exterior building walls and dimensions of the ceiling grid.

6.5.2 In this example, the ceiling grid line is located 50 mm [2 in.] (for example, one-half the thickness of a partition wall) inside the exterior wall and a result there is no actual or effective loss for this feature.

6.5.3 In contrast to Fig. 1, the location of the ceiling grids in have slightly different alignments and demonstrates how effective loss has been introduced into the design.

6.5.4 If the Condition Is—The ceiling grid is at the interior face of the exterior wall or some distance from the interior face of the exterior wall, then there is effective loss of floor area for people, furniture, and equipment, as shown in Figs. 2 and 3.

6.5.5 Then the Measurement Rule Is—Measure the effective loss from the finished surface of the interior face of the exterior wall to the next ceiling grid. (Refer to Figs. 2 and 3.) The hatched areas in each of these figures indicate the effective loss, which is the amount of extra floor area that will be required to align the office wall with the first ceiling grid. Sum the measurements to determine the effective loss for this feature.

6.6 Exterior Wall That Deviates from the Orthogonal:

6.6.1 If the Condition Is—The exterior wall(s) deviates from the orthogonal and reduces the proportion of floor area available for planning and fitup.

6.6.2 When an enclosed office is next to a non-orthogonal, or irregular, wall the actual floor area that would be required to

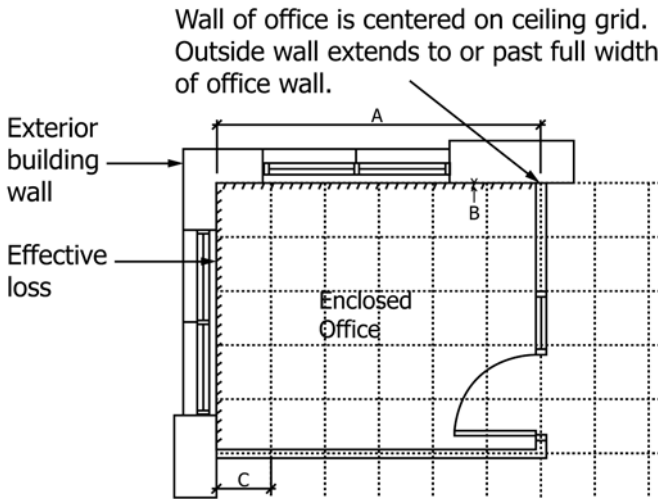

NOTE 1—A = 3660 mm [12 ft, 0 in.]  
 B = 50 mm [2 in.]  
 C = 600 mm [24 in.]

FIG. 2 Effective Loss Due to Alignment of Ceiling Grid at Face of Exterior Wall

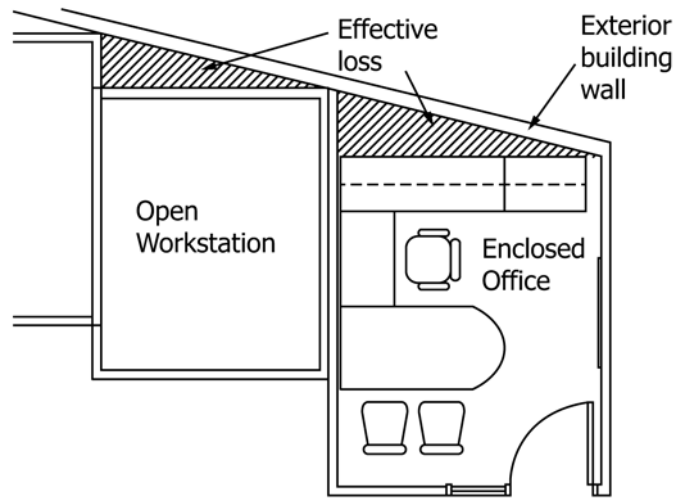
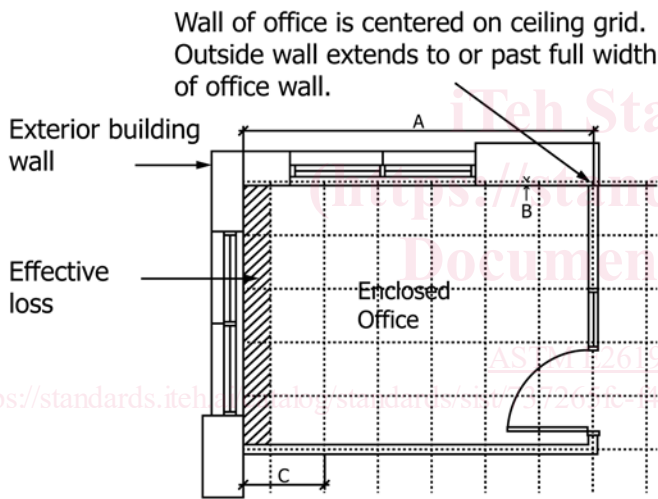

FIG. 4 Effective Loss Due to Non-Orthogonal Exterior Wall



NOTE 1—A = 3900 mm [13 ft, 0 in.]  
 B = 50 mm [2 in.]  
 C = 900 mm [36 in.]

FIG. 3 Effective Loss Due to Ceiling Grid Not Being Aligned at Face of Exterior Wall

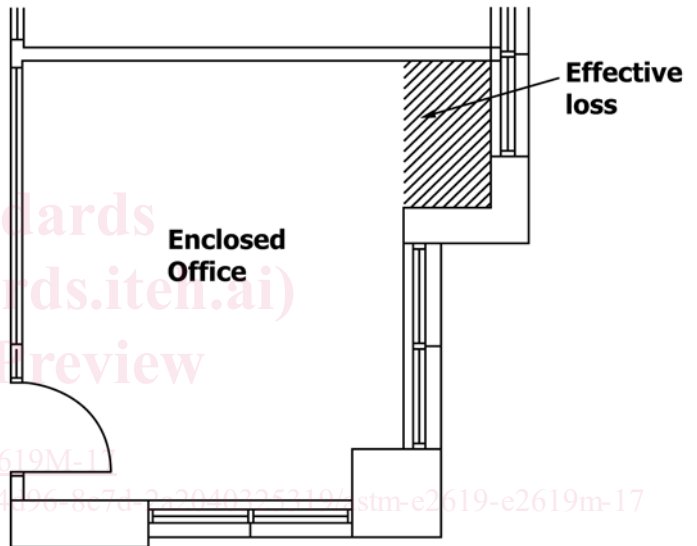

FIG. 5 Effective Loss Due to an Irregular Exterior Wall

layout the office would be larger than the area allowed for in the programming document. The floor area in excess of the allowed area is *effective loss*, as indicated by the hatched area in Figs. 4 and 5.

6.6.3 The same situation occurs when an open workstation is next to non-orthogonal wall. In Fig. 4, the exterior wall deviates from the orthogonal and creates *effective loss* as indicated by the hatched area.

6.6.4 *Then the Measurement Rule Is*—Measure the area between the interior face of the exterior wall and the first planning grid line at which a complete open workstation module or enclosed office module can be placed. Sum the measurements to determine the *effective loss*.

6.7 Perimeter Encroachments:

6.7.1 The size, shape, and location of perimeter encroachments at the exterior wall can reduce the density and efficiency, or both, of floor area usage on a floorplate.

6.7.2 Perimeter encroachments in the form of convector heaters or cooling units usually occur under the windows. While a projection may be very small (for example, a 75-mm [3-in.] protrusion into the interior) when it repeats around the outside of a floor, the total floor area taken up by these 75-mm [3-in.] projections can easily equate to the floor area of one or two workstations on a floor.

6.7.3 Projections and pilasters, or both, that occur at the exterior wall may also be intermittent, such as when columns and earthquake bracing embed only part of the way into an exterior wall—with the rest protruding into the interior space. When they are not aligned with the grid, or are intermittent, they interfere with the layout of workstations and offices, which can lead to significant amount of *actual* and *effective losses*. *Effective losses* will be even greater if perimeter projections are not uniformly projecting into the interior of the

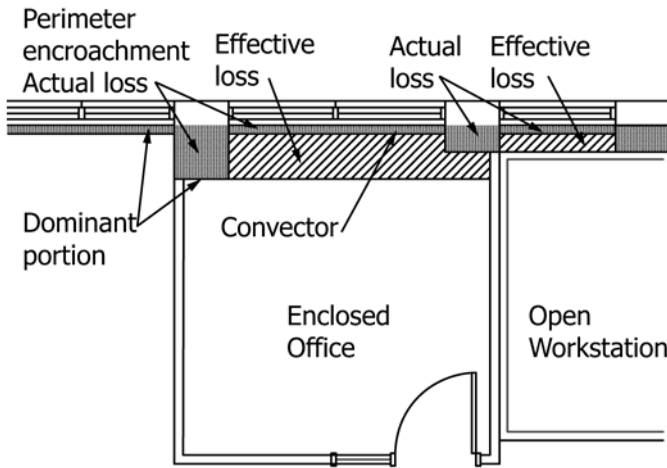

FIG. 6 Actual and Effective Losses Due to Perimeter Encroachments

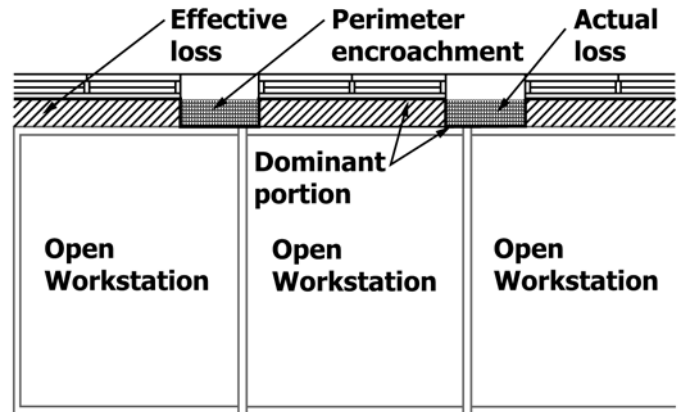

FIG. 7 Actual and Effective Losses Due to Uniformly Projecting Perimeter Encroachments

floor. However, if their location enables partitions that are aligned under the ceiling grid lines to meet the outside wall at the projection, the amount of *actual* and *effective* loss, or both, may be reduced.

6.7.3.1 *If the Condition Is*—The floor area between adjacent projecting perimeter encroachments cannot be used to place workstations at the inside face of the exterior wall. (Refer to Fig. 6.)

6.7.3.2 *Then the Measurement Rule Is*—Measure the *effective* loss to the inside finished face of the encroachment that most projects into the floor to determine the *effective* loss. Sum the measurements to determine the *effective* loss.

6.7.3.3 *If the Condition Is*—The floor area between uniformly projecting encroachments cannot be used effectively to place workstations at the inside face of the exterior wall.

6.7.3.4 *Then the Measurement Rule Is*—Measure to the inside finished face of the projecting encroachment to determine the *effective* loss. (Refer to example in Fig. 7.) Sum the measurements to determine the *effective* loss.

6.7.3.5 *If the Condition Is*—Perimeter encroachments do not uniformly project into the floor area. The floor area between adjacent non-uniformly projecting perimeter encroachments cannot be used to place workstations at the inside face of the exterior wall. (Refer to Fig. 8.)

6.7.3.6 *Then the Measurement Rule Is*—Measure from the inside finished face of the exterior wall to the inside face of the adjacent encroachment that most projects into the interior. Sum the measurements to determine the *effective* loss.

6.7.3.7 *If the Condition Is*—A portion of the floor area must be kept clear to access and service these encroachments. (Refer to Fig. 9.)

6.7.3.8 *Then the Measurement Rule Is*—Include the floor area that must be kept clear in the measurement. Sum the measurements to determine the *effective* loss.

6.8 Major Vertical Penetrations:

6.8.1 Ducts and Other Openings Through the Floor:

6.8.1.1 Ducts and other openings through a floor can constrain layouts within the plannable area. In some instances, these penetrations also cause inefficient layouts, especially if they occur in the path of primary or secondary circulation, so

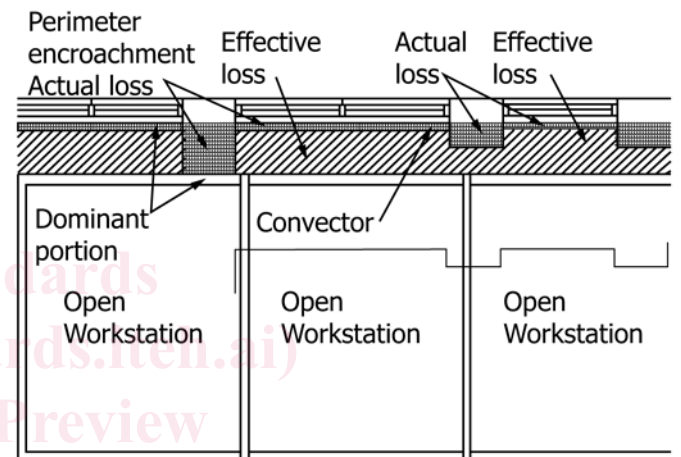

FIG. 8 Actual and Effective Losses Due to Non-Uniformly Projecting Perimeter Encroachments

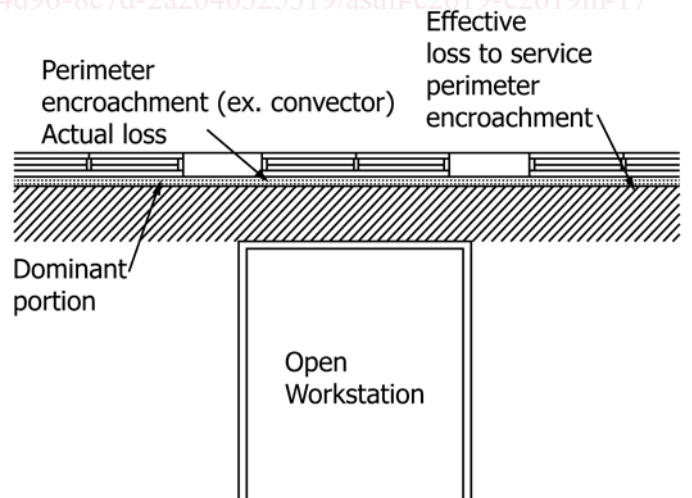

FIG. 9 Actual and Effective Losses Due to Restricted Area Kept Clear to Permit Service of Encroachment (Convactor)

that extra floor area is needed to provide the minimum required circulation—floor area that could have been used for a workstation, for example.

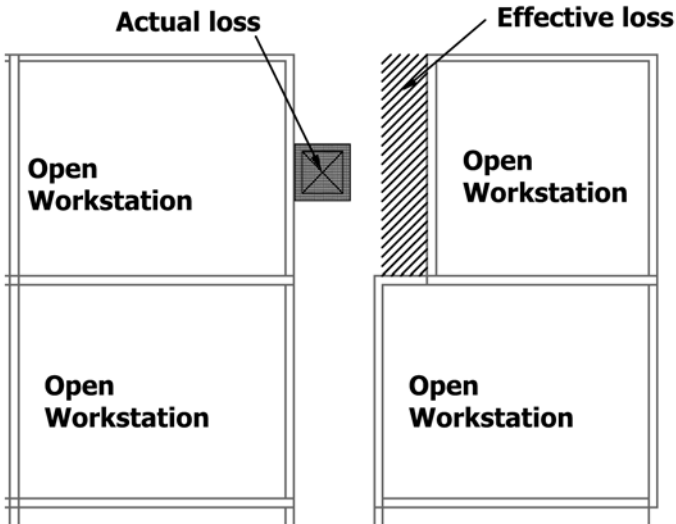

FIG. 10 Actual and Effective Losses Due to Duct Located in Secondary Circulation

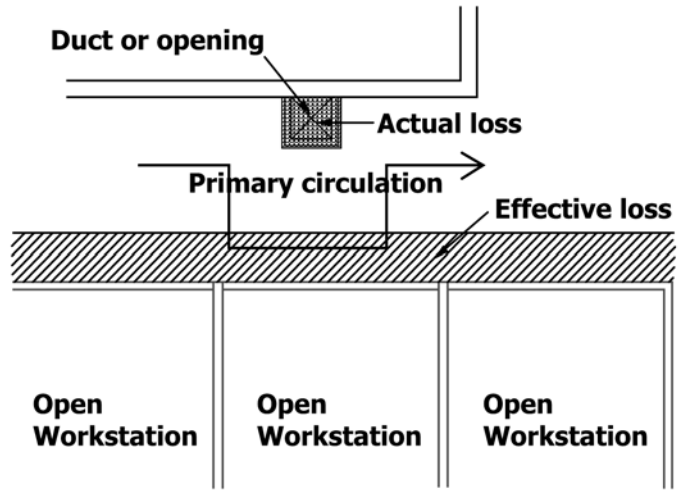

FIG. 11 Actual and Effective Losses Due to Duct Located in Primary Circulation

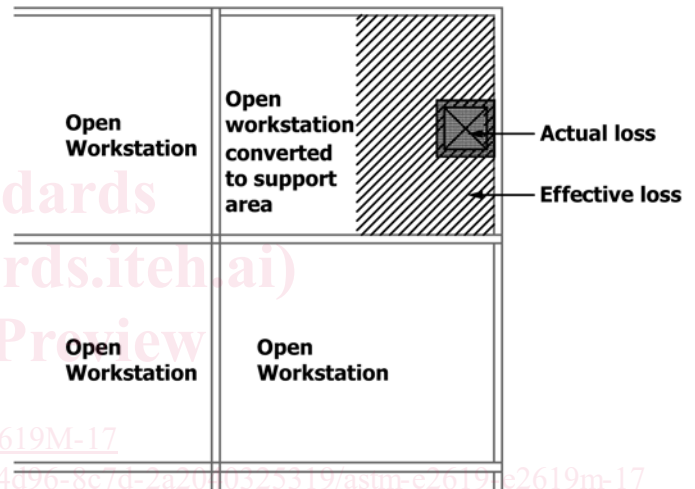

FIG. 12 Actual and Effective Losses Due to Duct Located Within a Standard Space Module

6.8.1.2 When air supply openings from the raised-access floor can be easily relocated to align with the standard space module or furnishings, there is no *actual* or *effective* loss of floor area. If openings or floor boxes from the raised-access floor to provide access to electrical, telecommunications, and LAN connections can be easily relocated with the standard space module or furnishings, there is no *actual* loss of area. If they cannot be relocated, then rules below apply.

6.8.1.3 *If the Condition Is*—Ducts and other openings are more than one square foot in size through a non-raised floor.

6.8.1.4 *Then the Measurement Rule Is*—Measure the area of the duct or opening and include the outside finished surface area of the duct or opening to determine the *actual* loss. Sum the measurements to determine the *actual* loss.

6.8.1.5 *If the Condition Is*—Ducts and other openings are more than one square foot in a non-raised floor and occur within primary and secondary circulation, or both. (Refer to Figs. 10 and 11.)

6.8.1.6 *Then the Measurement Rule Is*—Measure the area used by primary and secondary circulation to avoid the duct or other opening. This measured area is the *effective* loss. Sum the measurements to determine the *effective* loss.

6.8.1.7 *If the Condition Is*—Ducts and other openings are more than one square foot in a non-raised floor and are not within primary or secondary circulation.

6.8.1.8 *Then the Measurement Rule Is*—If these ducts and other openings interfere with the space module or furnishings, deduct half the floor area of the space module to determine the *effective* loss. Sum the measurements to determine the *effective* loss. (Refer to Fig. 12.)

6.9 Service Spaces:

6.9.1 When additional service spaces are required because of the shape and dimensions of the floor, such service areas can take up plannable floor area that would normally be available for programmed spaces.

6.9.2 *If the Condition Is*—A service area must be located where it prevents installation of a workstation or room and has leftover space adjacent to it that cannot be efficiently utilized.

For example, where an extra telecommunications room is required to accommodate shorter runs for wire, the location of the telecommunications room would depend on the maximum allowed length of wire to provide service to all portions of a floorplate and could cause this type of loss.

6.9.3 *Then the Measurement Rule Is*—Measure the *actual* losses of floor area taken up by additional telecommunications rooms and include the outside face of all surface finishes.

6.9.4 *If the Condition Is*—If telecommunications rooms are located outside the building core and require access from secondary circulation area these rooms will take up floor area that could have been used to place workstations or offices, and their area including their enclosing walls constitutes *effective* loss.

6.9.5 *Then the Measurement Rule Is*—Determine the *effective* loss by including the floor area required to access and service telecommunications rooms and all other adjacent area, which cannot be used effectively. (Refer to Fig. 13.) Sum the measurements to determine the respective *actual* and *effective* losses.